

AM5 Security System installation guide



© 2003 Directed Electronics, Inc. Vista, CA N436A 12-03

NOTE: This product is intended for installation by a professional installer only! Any attempt to install this product by any person other than a trained professional may result in severe damage to a vehicle's electrical system and components.

trademarks and copyrights

Bitwriter®, Clifford®, Code-Hopping®, Directed®, Doubleguard®, ESP®, FailSafe®, Ghost Switch®, Learn Routine™, Nite-Lite®, Nuisance Prevention®, NPC®, Revenger®, Silent Mode™, Soft Chirp®, Stealth Coding™, Stinger®, Valet®, Vehicle Recovery System™, VRS™, and Warn Away® are all Trademarks or Registered Trademarks of Directed Electronics, Inc.

contents

installation guide	1	data port—Bitwriter®	17
what is included	3	four-pin optional sensor harness .18	
control module	3	RED wire	18
installation points to remember . .3		BLACK wire	18
before beginning the installation: 4		BLUE, GREEN wires	18
after the install:	4	dealer master control loop	18
tools required	4	on-board dual stage shock sensor 19	
deciding on component location . .5		internal programming jumper . . .20	
control module	5	zones	21
integrated LED/Valet® switch . . .6		long term event history	21
starter kill relay	6	rapid resume logic	22
connecting your wires	6	high security disarm	22
obtaining constant 12V	6	feature programming	22
finding the 12V switched ignition		to enter feature programming rou-	
wire	7	tine	23
finding the door pin switch circuit 9		once a feature is programmed . .23	
main harness wire connection guide		accessing another feature23	
.	10	accessing another menu	24
main harness wiring diagram . . .10		exiting feature programming . . .24	
main harness wiring guide10		features #1 menu	24
auxiliary harness wire connection		features #2 menu	26
guide	16	transmitter learn routine	26
auxiliary harness wiring diagram 16		master dealer remotes	27
auxiliary harness wiring guide . .16		transmitter configurations	28
door lock harness wire connection		standard configuration	28
guide	17	troubleshooting	30
plug-in harnesses	17	wiring quick reference guide31	
integrated LED/Valet® switch . . .17			

what is included

- Control module
- 2 Four-button transmitters
- HF Plus receiver
- 12-pin main harness
- 4-pin sensor harness
- Integrated LED/Valet switch
- 7-pin door monitor/Aux harness
- 3-pin door lock harness

control module

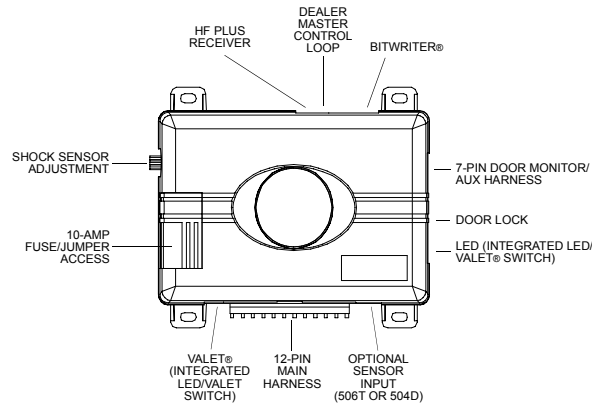

installation points to remember

This product represents many years of research and development. It is very sophisticated and should be installed by experienced security installers only. Please do not attempt installation of this product without reading this guide. The system has been designed to provide the ultimate in security, coupled with limitless convenience and expansion options.

This product is not intended for consumer installation and will have NO WARRANTY unless it is installed by an authorized dealer.

Do not disconnect the battery if the vehicle has an anti-theft coded radio. If equipped with an airbag, avoid disconnecting the battery if possible.

***IMPORTANT!** Please read this entire installation guide before beginning the installation. The installation of this security system requires interfacing with many of the vehicle's systems. Many new vehicles use low-voltage or multiplexed systems which can be damaged by low resistance testing devices, such as test lights or logic probes. Test all circuits with a high-quality digital multi-meter before making the connections.*

***IMPORTANT!** Many airbag systems will display a diagnostic code through their warning light after they lose power. Disconnecting the battery requires this code to be erased, a procedure that can require a trip to the dealer.*

before beginning the installation:

- Check with the customer to determine the integrated LED/Valet switch location.
- Remove the domelight fuse. This prevents accidentally draining the battery.
- Roll down a window to avoid being locked out of the car.

after the install:

- Test all functions. The "Using Your System" section of the Owner's Guide is very helpful when testing.
- When testing, don't forget that this system is equipped with Nuisance Prevention[®] Circuitry. NPC[™] can bypass both instant trigger zones, making them seem to stop working.
- Carefully reassemble the under-dash trim panels.
- Inspect the engine compartment for tools that may have been left behind.

tools required

This is a general list of tools required to complete the installation of this security system in most vehicles. Some vehicles may require additional tools.

- Digital multi-meter
- Wire cutters/strippers
- Nutdriver and/or socket set
- Panel removal tool

- Solderless terminal crimpers
- Cordless power drill
- Torx driver set
- Drill bit set
- Phillips head screwdriver
- Work light

deciding on component location

control module

Never put the control module in the engine compartment!

The first step in hot-wiring a vehicle is removing the driver's side underdash panel to access the starter and ignition wires. If the control module is placed just behind the driver's side dash it can easily be disconnected.

When locating the control module, try to find a secure location that will not require you to extend the harnesses' wires (they are 1.5 meters long). Keep it away from the heater core (or any other heat sources) and any obvious leaks.

Some good control module locations: Above the glove box, inside the center console, above the underdash fuse box, above the radio, etc.

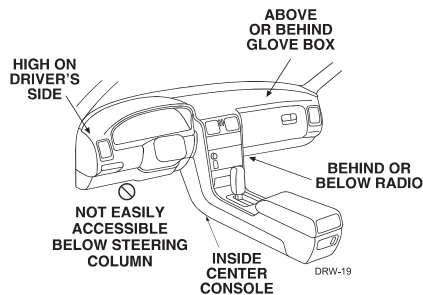

integrated LED/Valet® switch

Things to remember when positioning the integrated LED/Valet® switch:

- It should be visible from both sides and the rear of the vehicle, if possible.
- It needs at least 1-1/2" clearance to the rear.
- It is easiest to use a small removable panel, such as a switch blank or a dash bezel. Remove it before drilling your 5/16" hole.

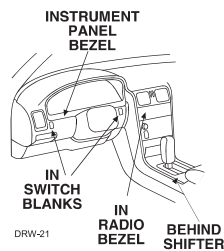

starter kill relay

If the Starter Kill Relay or its connections are immediately visible upon removal of the underdash panel, they can easily be bypassed. Always make the relay and its connections difficult to discern from the factory wiring! Exposed yellow butt connectors do not look like factory parts, and will not fool anyone! For this reason, routing the starter kill wires away from the steering column is recommended.

connecting your wires

Now that you have decided where each component will be located, you're going to find the wires in the car that the security system will be connected to.

***IMPORTANT!** Do not use a 12V test light to find these wires! All testing described in this manual is described using a digital multimeter.*

obtaining constant 12V

We recommend two possible sources for 12V constant: The (+) terminal of the battery, or the constant supply to the ignition switch. **Always install a fuse within 12 inches of this connection.**

IMPORTANT! Do not remove the fuse holder on the red (H1/11) wire. It ensures that the control module has it's own fuse, of the proper value, regardless of how many accessories are added to the main power feed.

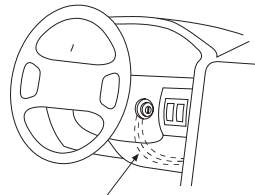

CONSTANT 12V DRW-23

finding the 12V switched ignition wire

The ignition wire is powered when the key is in the run or start position. This is because the ignition wire powers the ignition system (spark plugs, coil) as well as the fuel delivery system (fuel pump, fuel injection computer). Accessory wires, on the other hand, lose power when the key is in the start position to make more current available to the starter motor. Use the following procedure to find (+)12V with your multimeter.

1. Set to DCV or DC voltage (12V or 20V is fine).
2. Attach the (-) probe of the meter to chassis ground.
3. Probe the wire you suspect of being the ignition wire. The steering column harness or ignition switch harness is an excellent place to find this wire.

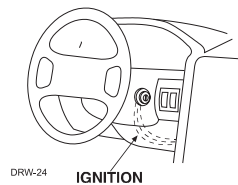

4. Turn the ignition key switch to the run position. If your meter reads (+)12V, go to the next step. If it doesn't, probe another wire.
5. Now turn the key to the start position. The meter display should stay steady, not dropping by more than a few tenths of a volt. If it drops close to or all the way to zero, go back to step 3. If it stays steady at (+)12V, you have found an ignition wire.

finding a parking light wire

The parking light wire is often found near the switch. Many cars have the switch built into the turn signal lever, and in these cars the parking light wire can be found in the steering column. The same wire is often available in the kick panel or running board.

(+) parking light wire

Use the following procedure to find (+) parking light wire with your multimeter.

1. Set to DCV or DC voltage (12V or 20V is fine).
2. Attach the (-) probe of the meter to chassis ground.
3. Probe the wire you suspect of being the parking light wire. Usually, the area near the headlight/parking light switch is an excellent area to start, as is the kick panel.
4. Turn on the parking lights. If your meter shows (+)12V, turn off the parking lights and make sure it goes back to zero.
5. If it does return to zero, turn the parking lights back on and, using the dash light dimmer control, turn the brightness of the dash lights up and down. If the meter changes more than a volt when using the dimmer, look for another wire. If it stays relatively close to (+)12V, you have found your parking light wire.

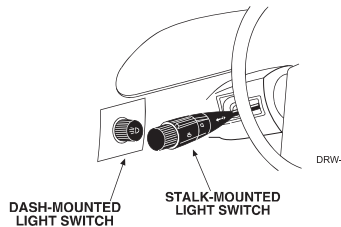

(-) parking light wire

Use the following procedure to find (-) parking light wire with your multimeter.

1. Set to DCV or DC voltage (12V or 20V is fine).
2. Attach the (+) probe of the meter to +12V.
3. Probe the wire you suspect of being the parking light wire. Usually, the area near the headlight/parking light switch is an excellent area to start, as is the kick panel.

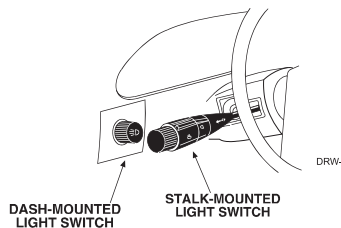

4. Turn on the parking lights. If your meter shows (+)12V, turn off the parking lights and make sure it goes back to zero.
5. If it does return to zero, turn the parking lights back on and, using the dash light dimmer control, turn the brightness of the dash lights up and down. If the meter changes more than a volt when using the dimmer, look for another wire. If it stays relatively close to (+)12V, you have found your parking light wire.

finding the door pin switch circuit

The best places to find the door switch wire are:

At the pin switch: When testing at the pin switch, check the wire to ensure that it "sees" all the doors. Often, the passenger switch will cover all the doors even if the driver's switch will not.

At the dome light: This may not be your best choice if the vehicle has delayed domelight supervision, but it will work in vehicles with completely diode-isolated pin switches.

you have determined the wire color, the easiest place to connect to the wire is often at the kick panel, at the windshield pillar, or in the running board. When an easy location is not available, running a wire to the domelight itself is often the best solution.

Use the following procedure to find the door pin switch wire with your multimeter.

1. Set to DCV or DC voltage (12V or 20V is fine).
2. In most cars, fasten the (+) probe of your meter to (+)12V constant.
3. Probe the wire you suspect of being the door trigger wire. If the meter reads (+)12V when any door is opened and the meter goes to 0 with the door closed, you have found a trigger wire.

***NOTE:** Make sure the wire you use "sees" all the doors! Some newer vehicles lack standard-type pinswitches. The dome light in these vehicles is turned on when the door handle is lifted. These usually have a wire coming out of the door into the kick panel which will provide a (-) trigger for all doors.*

main harness wire connection guide

main harness wiring diagram

H1/1	ORANGE	(-) 500mA Ground When Armed
H1/2	WHITE	(+)/(-) Light Flash Output
H1/3	WHITE/BLUE	(-) 200mA Channel 3 Output
H1/4	BLACK/WHITE	(-) 200mA Domelight Supervision Output
H1/5	GREEN	(-) Door Trigger Input
H1/6	BLUE	(-) Instant Trigger (Hood and Trunk Pin)
H1/7	VIOLET	(+) Door Trigger Input
H1/8	BLACK	(-) Chassis Ground Input
H1/9	YELLOW	(+) Ignition Input
H1/10	BROWN	(+) Siren Output
H1/11	RED	(+) 12V Constant Power Input
H1/12	RED/WHITE	(-) 200mA Auxiliary Channel/Delayed Accessory Output

main harness wiring guide

H1/1 ORANGE (-) 500 mA ground-when-armed output: This wire supplies a (-) ground as long as the system is armed. This output ceases as soon as the system is disarmed. This wire controls operation of the pre-wired starter kill relay and can be used to control other optional accessories.

NOTE: If connecting the orange wire to control another module, such as a 529T or 530T window controller, a 1 amp diode (type 1N4004) will be required. Insert the diode as shown below.

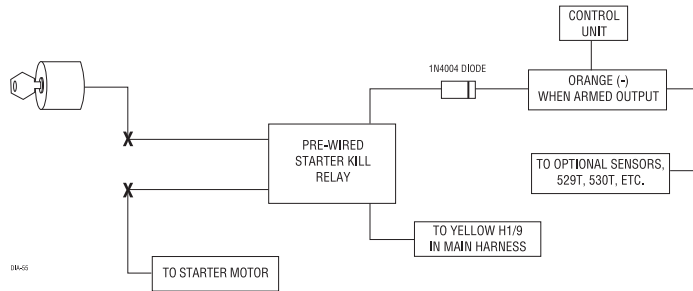

IMPORTANT! Never interrupt any wire other than the starter wire.

H1/2 WHITE light flash output: As shipped, this wire should be connected to the (+) parking light wire. It will supply a (+) 10A output. If the light flash polarity fuse jumper inside the unit is moved to the opposite position (see Internal Jumpers), this wire supplies a (-) 10A output. This is suitable for driving (-) parking light wires.

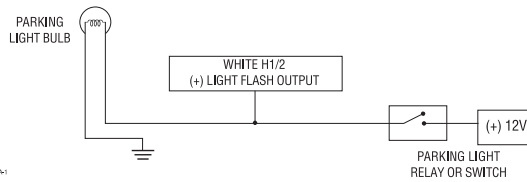

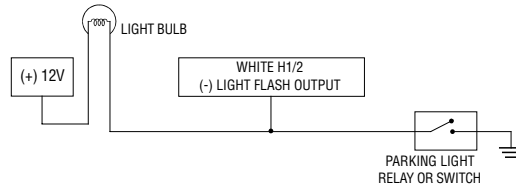

H1/3 WHITE/BLUE (-) 200 mA channel 3 output: This wire supplies a (-) 200 mA output whenever the button on transmitter programmed for channel 3 is pressed. This output is used to control optional accessories. This channel can be programmed to provide the following types of output (see feature programming section of this guide).

1. A validity output will send a signal as the transmission is received.
2. Second unlock output when the unlock button is pressed a second time after disarming the system. This can be used to unlock the passenger doors when installing progressive door locks.

***IMPORTANT!** Zones 2 and 4 are shunted when this channel becomes active. Zones 2 and 4 reactivate 5-seconds after this output ceases.*

***NOTE:** Other features can be programmed to channel 3 using the Bitwriter®.*

H1/4 BLACK/WHITE (-) 200 mA domelight-supervision output: Connect this wire to the optional domelight supervision relay.

***IMPORTANT!** This output is only intended to drive a relay. It cannot be connected directly to the domelight circuit, as the output cannot support the current draw of one or more bulbs.*

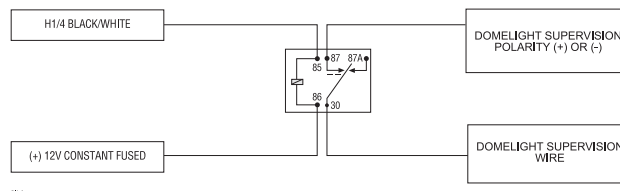

H1/5 GREEN (-) door trigger input: Most vehicles use negative door trigger circuits. Connect the green wire to a wire which shows ground when any door is opened. In vehicles with factory delays on the domelight circuit, there is usually a wire that is unaffected by the delay circuitry.

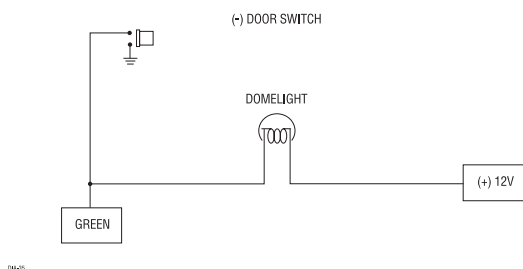

H1/6 BLUE (-) instant trigger: This input will respond to a negative input with an instant trigger. It is ideal for hood and trunk pins and will report on zone one.

H1/7 VIOLET (+) door trigger input: This wire is used in vehicles that have a positive (+) switched dome light circuit. Connect the violet wire to a wire that shows (+)12V when any door is opened, and ground when the door is closed.

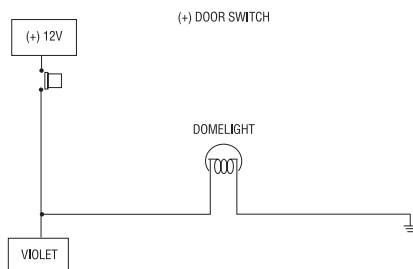

H1/8 BLACK (-) chassis ground connection: Connect this wire to bare metal, preferably with a factory bolt rather than your own screw. Screws tend to either strip or loosen with time. All components, should be grounded to the same point in the vehicle if possible.

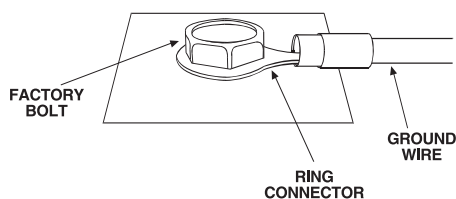

H1/9 YELLOW (+) ignition input: Connect this wire to the (+)12V ignition wire. This wire must show (+)12V with the key in Run position and during cranking. Take care to insure that this wire cannot be shorted to the vehicle chassis at any point.

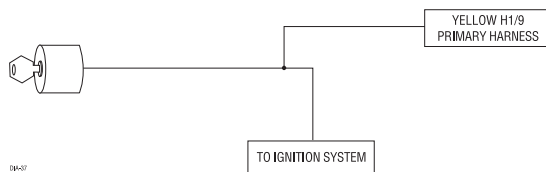

H1/10 BROWN (+) siren output: This output can be used if an optional siren is installed. Connect this to the RED wire of the siren. Connect the BLACK wire of the siren to (-) chassis ground, preferably at the same point as the control module's BLACK ground wire.

H1/11 RED (+)12V constant power input: Before connecting this wire, remove the supplied fuse. Connect to the battery positive terminal or the constant 12V supply to the ignition switch.

NOTE: Always use a fuse within 12 inches of the point you obtain (+)12V. Do not use the 15A fuse in the harness for this purpose. This fuse protects the module itself.

H1/12 RED/WHITE (-) 200mA auxiliary channel/delayed accessory output: If programmed for an auxiliary output, this wire will provide a (-) pulse when the lock button on the factory transmitter is pressed twice within three seconds. This output can be used to control optional accessories. If programmed for delayed accessory output, this wire will provide (-) ground when the ignition is turned off and will continue to output (-) ground until a door is opened then closed. This can be used to energize the accessory circuit in the vehicle to keep the radio and other accessories on after the ignition is turned off.

IMPORTANT! Never use this wire to drive anything but a relay or a low-current input! This transistorized output can only supply (-) 200 mA, and connecting directly to a solenoid, motor, or other high-current device will cause the module to fail.

NOTE: Zones 2 and 4 are shunted when this channel becomes active. Zones 2 and 4 reactivate 5-seconds after this channel's output ceases.

auxiliary harness wire connection guide

auxiliary harness wiring diagram

H2/1	BROWN	(-) Horn Honk Output
H2/2	GREEN	No Function
H2/3	RED	No Function
H2/4	BLUE	No Function
H2/5	GRAY	No Function
H2/6	VIOLET/BLACK	(-) 200mA Channel 4 Output
H2/7	YELLOW/BLACK	No Function

auxiliary harness wiring guide

H2/1 BROWN (-)horn honk output: This wire supplies a 200 mA (-) output that can be used to honk the vehicle's horn. It provides a pulsed output when the security system is armed/disarmed and in the triggered sequence or in panic mode. In most vehicles with (-) horn circuits this wire can control the vehicle's horn without adding a relay. If the vehicle has a (+) horn circuit, an optional relay must be used to interface with the vehicle's horn circuit.

***IMPORTANT!** Never use this wire to drive anything but a relay or a low-current input! This transistorized output can only supply (-) 200 mA, and connecting directly to a solenoid, motor, or other high-current device will cause the module to fail.*

H2/2 GREEN no function.

H2/3 RED no function.

H2/4 BLUE no function.

H2/5 GRAY no function.

H2/6 VIOLET/BLACK (-) 200 mA channel 4 output: This wire supplies a (-) 200 mA output whenever the button on transmitter programmed for channel 4 is pressed. This output is used to control optional accessories.

IMPORTANT! Zones 2 and 4 are shunted when this channel becomes active. Zones 2 and 4 reactivate 5-seconds after this output ceases.

H2/7 YELLOW/BLACK no function.

door lock harness wire connection guide

H3/A	GREEN	(-) Lock, (+) Unlock Output
H3/B		Not Used
H3/C	BLUE	(-) Unlock, (+) Lock Output

The control module can control 2 common power door lock types without any additional parts. With certain vehicles, or if an actuator is to be installed, either a 451M Door Lock Relay Satellite or two relays will be required. Refer to TechTips document 1041.

plug-in harnesses

integrated LED/Valet® switch

The integrated LED/Valet® switch should be accessible from the driver's seat. The Valet® part of the integrated LED/Valet® switch plugs into the blue port on the side of the unit. Check for rear clearance before drilling a 5/16-inch hole and mounting the switch. The LED part of the integrated LED/Valet® switch operates at 2V DC and plugs into the white port on the side of the unit. Make sure the LED wires are not shorted to ground as the LED will be damaged.

data port—Bitwriter®

The black three-pin port can be used for programming the unit or to accommodate a serial controller. The Bitwriter® is available for programming through this port.

four-pin optional sensor harness

RED wire

The red wire supplies constant power to the optional sensor.

BLACK wire

The black wire supplies ground to the optional sensor.

BLUE, GREEN wires

The blue and green wires are multiplex inputs. They are both tied to the same zone. If an input of less than 0.8 seconds is supplied to either wire the Warn-Away® response will occur. An input longer than 0.8 seconds to either wire will initiate the triggered sequence and report zone 4. This port can be used for optional sensors such as: the 506T—glass breakage sensor, or the 508D—field disturbance sensor.

dealer master control loop

This 2-pin black connector when removed from the control module will reset the system back to allow the full set of customer settings and remove the dealer remote from memory.

on-board dual stage shock sensor

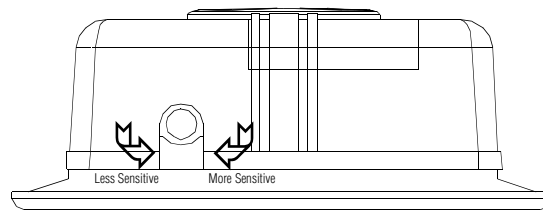

There is a dual-stage shock sensor inside the control module. Adjustments are made via the rotary control as indicated above. Since the shock sensor does not work well when mounted firmly to metal, we recommend against screwing down the control module. The full trigger of the onboard shock sensor reports zone 2. See Table of Zones.

NOTE: When adjusting the sensor, it must be in the same mounting location that it will be after the install is completed. Adjusting the sensor and then relocating the module requires readjustment.

internal programming jumper

A 10A fuse is used as both a fuse and a program jumper. This jumper determines the light flash output polarity. In the (+) position, the on-board relay is enabled and the unit will output (+)12V on the WHITE wire, H1/2. In the (-) position, the on-board relay is enabled for (-) output on the WHITE wire, H1/2. To access the jumper, remove the sliding door from on top of the control module, as shown below.

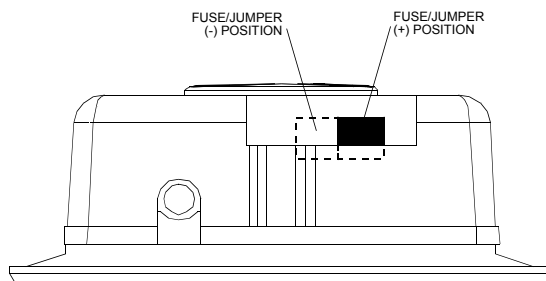

zones

Zone Number	Trigger Type	Input Description
1	Instant trigger	Hood and/or trunk pin switches.
2	Multiplexed input	Heavy impact from on-board Doublegurard® shock sensor.
3	Two-stage, progresses from warning to full alarm	Door switch circuit.
4	Multiplexed	Optional sensor, inputs shorter than 0.8 seconds will trigger Warn Away® response, while inputs longer than 0.8 seconds will instantly trigger full alarm.
5	Two-stage (similar to zone 3)	Ignition input.

NOTE: The Warn Away® response do not report on the LED.

long term event history

The control module will store the last 2 triggers (zone numbers) in memory. To access the event history use the following procedure.

1. Turn the ignition switch off and press and hold the integrated LED/Valet® switch.
2. While holding the integrated LED/Valet® switch turn the ignition On.
3. Release the integrated LED/Valet® switch.
4. Within 5-seconds, press and release the integrated LED/Valet® switch.

The LED will flash in groups indicating the last two zones reported triggered. For example, if zone 2 and 3 were the last two zones to be triggered, the LED will flash two times followed by a pause and then flash three times followed by a pause.

NOTE: The Warn Away® response does not report on the LED.

The Long Term Event History will exit if the ignition is turned off or there is no activity for 60-seconds.

rapid resume logic

The current state of the alarm will be stored in non-volatile memory. If power is lost and then reconnected, the system will recall the stored state from memory (arm, disarm, and Valet® mode).

high security disarm

If the system is armed and triggered and either the lock or unlock button on your remote are pressed within 5-seconds, the alarm will cease horn output. The horn will chirp once for Arm if the lock button was pressed. The horn will chirp four times for Disarm if the unlock button was pressed. If the lock or unlock button is used after the 5-second period during a system alarm, the horn will silence, but the system will remain in the armed state (there will be no horn honk).



feature programming

The feature programming routine is used to access and change any of the feature settings in the two menus below. The feature settings can be accessed and changed by using one of the following:

- The integrated LED/Valet® switch to enter the feature programming routine.
- Use the Directed Electronics Bitwriter®.

NOTE: If Feature Programming Lockout is set to ON, all features will be locked and can only be accessed by using a Bitwriter®.

to enter feature programming routine

1. Open a door.
2. Turn the ignition on and then off.
3. Within 5-seconds, press and hold the integrated LED/Valet® switch. After 3-seconds the horn will sound once to indicate entry into the first features menu. To select the second features menu, continue to hold the integrated LED/Valet® switch until the horn sounds twice. Once the desired menu is selected, release the integrated LED/Valet® switch.
4. Within 5-seconds, press and release the integrated LED/Valet® switch the number of times corresponding to the desired feature listed below. Then press the integrated LED/Valet® switch one more time and **hold**. The horn will sound the number of times equal to the feature number selected.
5. While holding the integrated LED/Valet® switch, select the feature by either pressing  for 1 short horn honk setting or pressing  for 2 short horn honk setting.

once a feature is programmed

- Another feature(s) can be programmed.
- The other feature menu can be selected.
- The Learn Routine can be exited.

accessing another feature

- Release, then press and release the integrated LED/Valet® switch the number of times to advance from the feature just programmed to the next feature desired.
- Press and **hold** the integrated LED/Valet® switch once more.

accessing another menu

- Release, then press and hold the integrated LED/Valef® switch.
- After 3-seconds, the unit will advance to the next menu and the horn will sound the number of times corresponding to the menu selected (once or twice).

exiting feature programming

- Close the door.
- Turn the ignition On.
- No activity for 15-seconds.
- Press and release the integrated LED/Valef® switch too many times.

features #1 menu

Default settings are shown in **bold**.

NOTE: Feature step 5 is not applicable to the 436A.

Feature Step	Lock Button (one chirp)	Unlock Button (two chirps)
1	Active arming	Passive arming
2	Chirps ON	Chirps OFF
3	Door Trigger Error Chirp ON	Door Trigger Error Chirp OFF
4	Ignition-Controlled Domelight ON	Ignition-Controlled Domelight OFF
5	Panic Enabled (OEM upgrade)	Auxiliary Output Enabled (OEM upgrade)
6	Auxiliary Output	Delayed Accessory Output
7	Delayed Door Trigger	Instant Door Trigger
8	Sensor shunt zones 2 & 4	All zones
9	Siren Duration–30 seconds	Siren Duration–60 seconds
10	Valet® switch input: 1-pulse	Valet® switch input: 2-5 pulses
11	Horn pulse honk duration 0.020 seconds (does not affect full trigger pulse duration)	0.030, 0.040, 0.050 seconds

features #2 menu

Default settings are shown in **bold**.

Feature Step	Lock Button (one chirp)	Unlock Button (two chirps)
1	Ignition-Controlled Locking ON	Ignition-Controlled Locking OFF
2	Ignition-Controlled UnLocking ON	Ignition-Controlled Unlocking OFF
3	Active Locking	Passive Locking
4	Door Lock Pulse Duration–0.8 sec.	Door Lock Pulse Duration–3.5 sec.
5	Single Unlock Pulse	Double Unlock Pulse
6	Channel 3: Validity	Channel 3: Second Unlock
7	Code Hopping ON	Code Hopping OFF

transmitter learn routine

1. **Key.** Turn the key to the ON position.
2. **Choose.** Within 5 seconds, press and release the integrated LED/Valet® switch the number of times corresponding to the desired channel listed below. Once you have selected the channel, press the switch once more and HOLD it. The LED will flash and the horn will honk (if connected) to confirm the selected channel. Do not release the integrated LED/Valet® switch.
3. **Transmit.** While holding the integrated LED/Valet® switch, press the button from the transmitter that you wish to assign to the selected channel. The unit will chirp indicating successful programming. It is not possible to teach a transmitter button to the system more than once.

4. **Release.** Once the code is learned, the integrated LED/Valet® switch can be released.

Channel Number	Function	Wire Color
1	Auto learn standard configuration	
2	Arm/Disarm/Panic	
3	Channel 2	
4	Channel 3	WHITE/BLUE
5	Channel 4	VIOLET/BLACK
6	Arm only	
7	Disarm only	
8	Panic only	
9	Delete all transmitters	

master dealer remotes

A master dealer remote can be programmed into the system for demonstration purposes. Generally, each salesman would carry a remote that would operate all the cars on the lot equipped with this system. The dealer remotes are binary transmitters that are detuned slightly in order to limit transmitting range. The dealer remote can be taught to the system by following the Transmitter Learn Routine.

When installing the system, it is possible to preset all of the operation settings using the master dealer remote. However, when the system is operated using the master dealer remote, a special set of dealer default settings are followed. The dealer default settings are used to ensure that every vehicle equipped with this system is protected at all times. Only the settings listed below are affected. When using a master dealer remote, the system operates as follows:

- Passive arming

- Confirmation honks off
- Ignition lock and unlock on (if installed)
- Passive locking (if programmed on)
- Ignition domelight on
- Security features on
- Valet® mode disabled

The dealer default settings only affect the settings listed above. The remaining features control outputs of the system that must be programmed to meet the needs of the installation. Once the vehicle is delivered to the end user, the customer transmitter should be programmed to the system. This will delete the master dealer remote and return the security system to normal operation. The system will then operate according to how the operating settings have been preset. It is also possible to reprogram the operating settings by following the feature programming section of this guide.

transmitter configurations

The transmitters can be programmed with the standard or single button arm/disarm configurations by using the Auto Learn functions in the Transmitter/Receiver Learn Routine.

standard configuration

A remote that uses the standard configuration operates similarly to many factory keyless entry remotes. A standard configuration transmitter allows arming, disarming, and Panic Mode activation with separate buttons. When programmed for standard configuration, the transmitter buttons are assigned to the following functions:



operates Arm only



operates Disarm only

 operates Channel 2 and Silent Mode

 operates Panic

 and  operate Channel 3

 and  operate Channel 4

The standard configuration also allows the user to utilize Multi-Level Security Arming, a feature that cannot be accessed from a single button arm/disarm configuration transmitter.

troubleshooting

starter kill does not work:

- Is the correct starter wire being interrupted? If the car starts when the starter kill relay is completely disconnected, the wrong starter wire has been cut and interrupted.
- Is the yellow wire connected to "true" ignition? Make sure this wire is connected to a wire that has power in the run and start positions.

the Valet® switch does not work.

- Is it plugged into the correct socket? See the integrated LED/Valet® Switch section. Is the H1/9 YELLOW wire properly connected? See Primary Harness (H1) Wire Connection Guide section of this guide.

status LED does not work.

- Is the LED plugged into the small white port on the side of the control unit? See integrated LED/Valet® Switch section.

door locks operate backwards.

- This unit has easily-reversed lock/unlock outputs. Recheck Harness 3, (+/-) Door Lock Outputs section to see if you have reversed these.

the horn honks when the unit enters panic mode, but the confirmation honks do not work when locking and unlocking.

- Are the confirmation honks turned on in programming? See Operating Settings Learn Routine and Feature Descriptions sections.

I can get into programming and change the feature settings, but when I use the remote the settings seem to change.

- Are you using a binary, master dealer remote? Remember, you can program the settings using a master dealer remote. However, the unit will follow the dealer default settings when using a binary remote to operate the system.

wiring quick reference guide

